



# SC20J120A

## 主要参数 MAIN CHARACTERISTICS

$V_{RRM}$	1200V
$I_F, T_C \leq 150^\circ\text{C}$	20A
$Q_C \text{ Typ}$	95nC

## 封装 Package

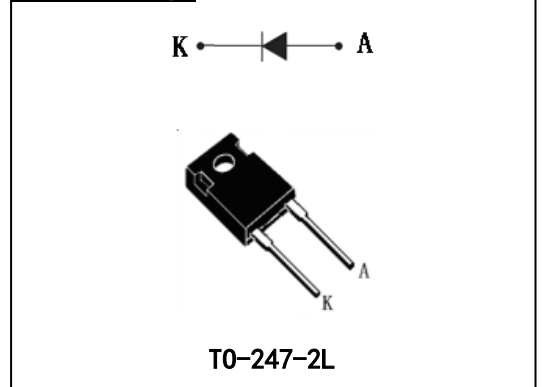

## 用途

- 光伏逆变器
- 开关模式电源
- 高压 DC/DC 转换器
- 电池充电器
- 电动驱动
- 不间断电源

## APPLICATIONS

- Solar Inverters
- Switch Mode Power Supplies
- High Voltage DC/DC Converters
- Battery Chargers
- Motor Drives
- Uninterruptable power supplies

## 产品特性

- 高阻断电压
- 零反向恢复电流
- 零正向恢复电压
- 高频率应用
- 不受温度影响的开关特性
- 快速开关
- 正温度系数
- RoHS 产品

## FEATURES

- High Blocking Voltage
- Zero Reverse Recovery Current
- Zero Forward Recovery Voltage
- High-Frequency Operation
- Temperature-Independent Switching Behavior
- Extremely Fast Switching
- Positive Temperature Coefficient on  $V_F$
- RoHS product

## 订货信息 ORDER MESSAGE

订货型号 Order codes	印记 Marking	封装 Package
无卤-条管 Halogen-Free-Tube		
SC20J120A-GE-BR	SC20J120A	TO-247-2L



## 绝对最大额定值 ABSOLUTE RATINGS (Tc=25°C)

项 目 Parameter	符 号 Symbol	数 值 Value	单 位 Unit
反向重复峰值电压 Repetitive Peak Reverse Voltage	$V_{RRM}$	1200	V
反向浪涌峰值电压 Surge Peak Reverse Voltage	$V_{RSM}$	1200	V
反向直流电压 DC Blocking Voltage	$V_{DC}$	1200	V
正向平均电流 Continuous Forward Current	$I_F$ Tc=150°C	20	A
正向重复浪涌电流 Repetitive Peak Forward Surge Current	$I_{FRM}$	100	A
正向非重复浪涌电流 Non-Repetitive Peak Forward Surge Current	$I_{FSM}$	140	A
非重复正向峰值电流 Non-Repetitive Peak Forward Current	$I_{F,Max}$	1200	A
耗散功率 Power Dissipation	$P_{tot}$ Tc=25°C Tc=150°C	272 118	W
最高结温及存储温度 Operating and Storage Temperature Range	$T_J, T_{STG}$	-55~+175	°C
引线最高焊接温度 Maximum Lead Temperature for Soldering Purposes	$T_L$	300	°C





## 电特性 ELECTRICAL CHARACTERISTICS

项 目 Parameter	符 号 Symbol	测试条件 Tests conditions	最小 Min	典型 Typ	最大 Max	单位 Units
正向电压 Forward Voltage	$V_F$	$I_F = 20A$ $T_J = 25^\circ C$ $I_F = 20A$ $T_J = 175^\circ C$	-	1.5 2.2	1.8 3.0	V
反向电流 Reverse Current	$I_R$	$V_R = 1200 V$ $T_J = 25^\circ C$ $V_R = 1200 V$ $T_J = 175^\circ C$		2 20	20 100	$\mu A$
总储存电荷 Total Capacitive Charge	$Q_C$	$V_R = 800V$ , $T_J = 25^\circ C$ $Q_C = \int_0^{V_R} C(V)dV$		95		nC
总电容 Total Capacitance	C	$V_R = 0 V$ , $T_J = 25^\circ C$ , $f = 1 MHz$ $V_R = 400V$ , $T_J = 25^\circ C$ , $f = 1 MHz$ $V_R = 800V$ , $T_J = 25^\circ C$ , $f = 1 MHz$		1430 89 65		pF
电容储存能量 Capacitance Stored Energy	$E_C$	$V_R = 800 V$		50		$\mu J$

## 热特性 THERMAL CHARACTERISTICS

项 目 Parameter	符 号 Symbol	典型值 Typ	单 位 Unit
		TO-247-2L	
结到管壳的热阻 Thermal Resistance Junction to Case	$R_{th(j-c)}$	0.55	$^\circ C/W$





典型性能 Typical Performance

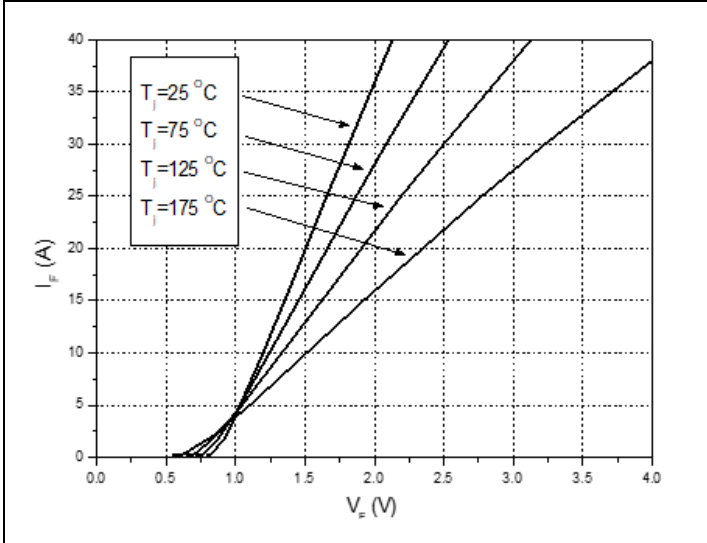

Forward Characteristics

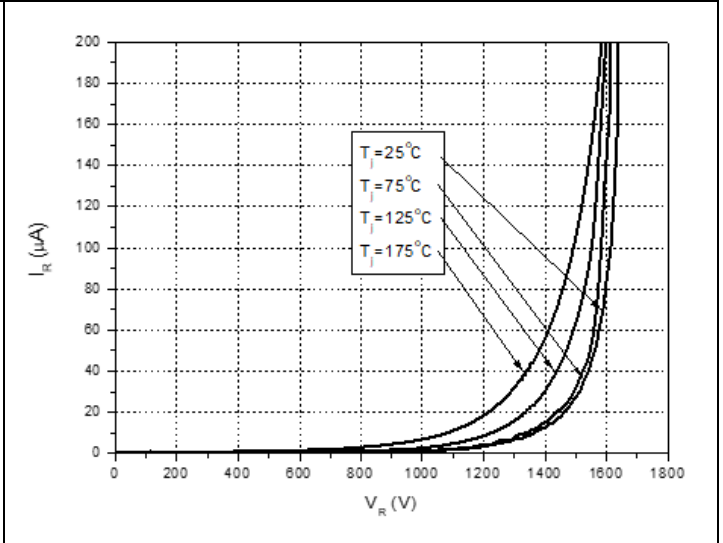

Reverse Characteristics

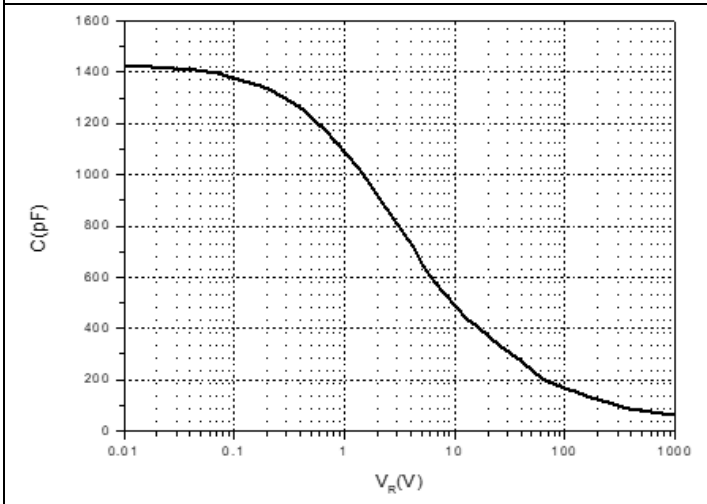

Capacitance vs. Reverse Voltage

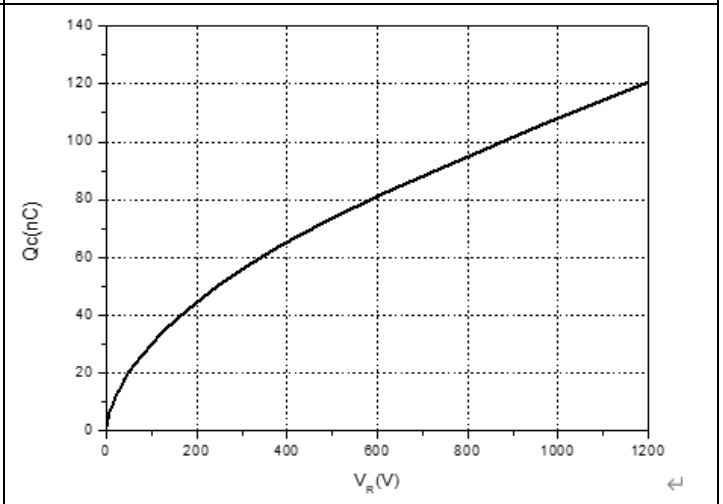

Capacitance Charge vs. Reverse Voltage

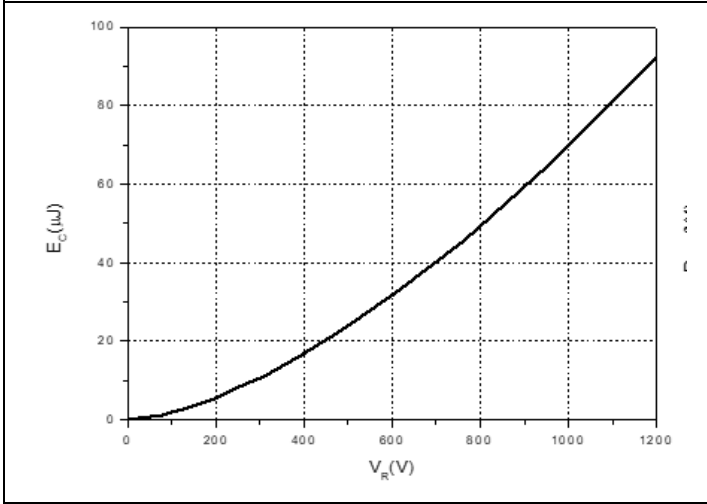

Capacitance Stored EnergyFigure

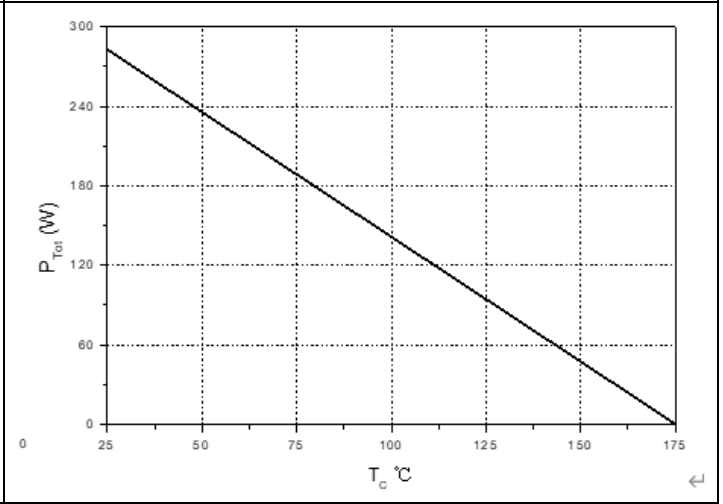

Power Derating

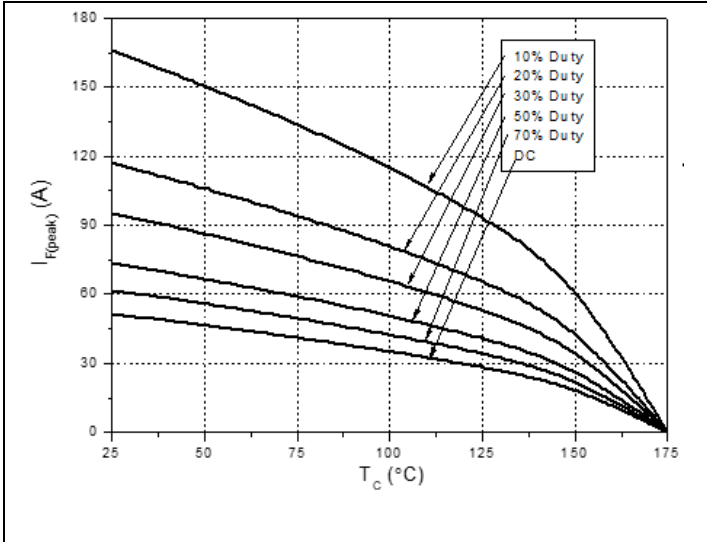

Current Derating

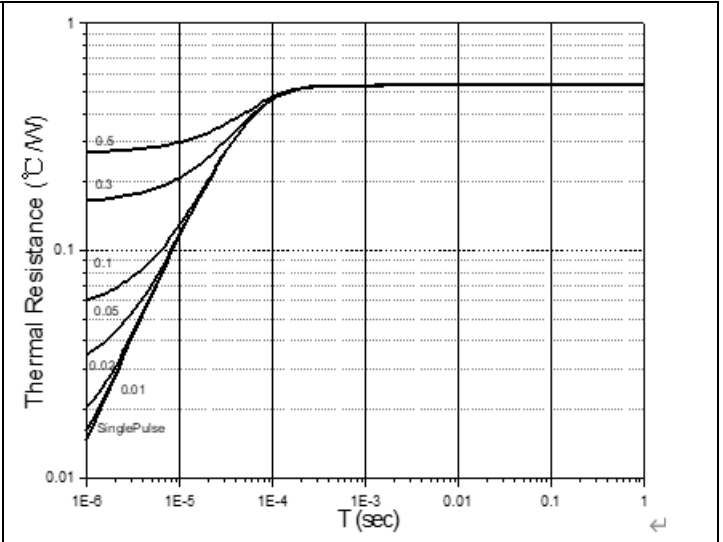

Transient Thermal Impedance



## 外形尺寸 PACKAGE MECHANICAL DATA

## TO-247-2L

单位 Unit: mm

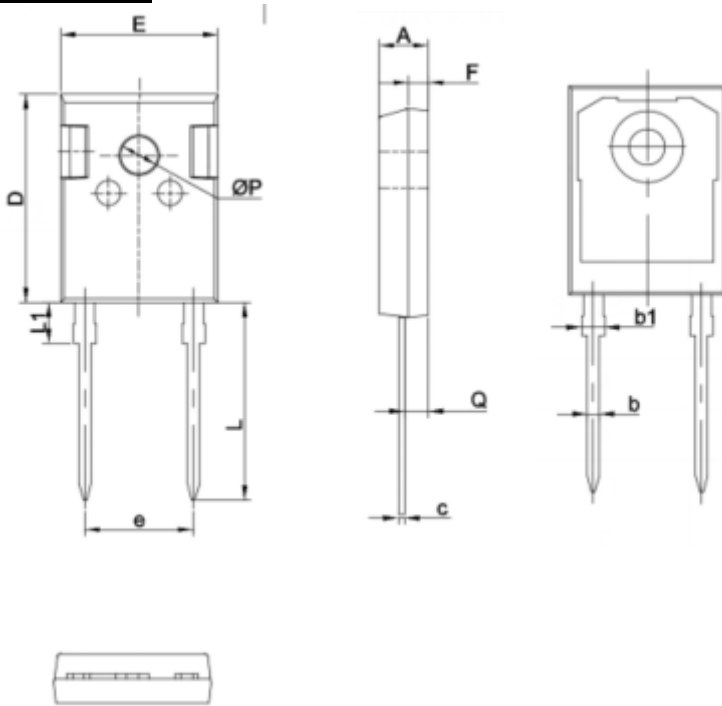

SYMBOL	MM	
	MIN	MAX
A	4.80	5.20
b	1.10	1.30
b1	1.95	2.25
c	0.50	0.70
D	20.80	21.20
E	15.60	16.00
F	1.85	2.15
e	10.73	11.03
L	19.62	20.22
L1	3.93	4.33
ØP	3.40	3.80
Q	2.26	2.56





### 注意事项

1. 吉林华微电子股份有限公司的产品销售分为直销和销售代理，无论哪种方式，订货时请与公司核实。
2. 购买时请认清公司商标，如有疑问请与公司本部联系。
3. 在电路设计时请不要超过器件的绝对最大额定值，否则会影响整机的可靠性。
4. 本说明书如有版本变更不另外告知。

### NOTE

1. Jilin Sino-microelectronics co., Ltd sales its product either through direct sales or sales agent , thus, for customers, when ordering , please check with our company.
2. We strongly recommend customers check carefully on the trademark when buying our product, if there is any question, please don't be hesitate to contact us.
3. Please do not exceed the absolute maximum ratings of the device when circuit designing.
4. Jilin Sino-microelectronics co., Ltd reserves the right to make changes in this. specification sheet and is subject to change without prior notice.

### 联系方式

#### 吉林华微电子股份有限公司

公司地址：吉林省吉林市深圳街 99 号

邮编：132013

总机：86-432-64678411

传真：86-432-64665812

网址：[www.hwdz.com.cn](http://www.hwdz.com.cn)

### CONTACT

#### JILIN SINO-MICROELECTRONICS CO., LTD.

ADD: No.99 Shenzhen Street, Jilin City, Jilin Province, China.

Post Code: 132013

Tel: 86-432-64678411

Fax: 86-432-64665812

Web Site: [www.hwdz.com.cn](http://www.hwdz.com.cn)

