



# MJE15032(NPN) MJE15033(PNP)

## 用途

- 音频功放高频驱动

## 产品特性

- 高集电极电压:  $V_{CEO}=250V$  (min)
- NPN-PNP 互补
- 宽安全工作区
- 环保 (RoHS) 产品

## APPLICATIONS

- High frequency drivers in audio amplifiers

## FEATURES

- High collector voltage:  $V_{CEO}=250V$  (min)
- Complementary NPN-PNP
- Exceptional Safe Operating Area
- RoHS Devices

## 封装 Package

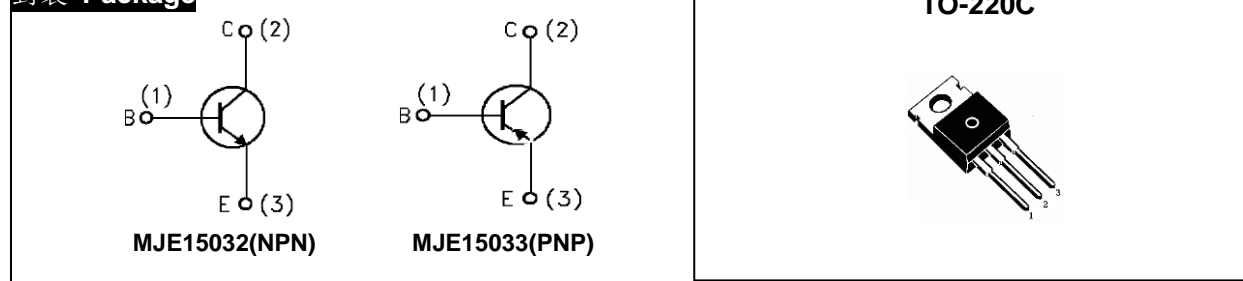

## 订货信息 ORDER MESSAGE

订货型号 Order codes				印 记 Marking	封 装 Package
有卤-条管 Halogen-Tube	无卤-条管 Halogen Free-Tube	有卤-盒装 Halogen-Reel	无卤-盒装 Halogen Free-Reel		
MJE15032-C-B	N/A	N/A	N/A	MJE15032	TO-220C
MJE15033-C-B	N/A	N/A	N/A	MJE15033	TO-220C

## 绝对最大额定值 ABSOLUTE RATINGS ( $T_c=25^\circ\text{C}$ unless otherwise noted)

项 目 Parameter	符 号 Symbol	数 值 Value	单 位 Unit
集电极—基极直流电压 Collector- Base Voltage	$V_{CBO}$	250	V
集电极—发射极直流电压 Collector- Emitter Voltage	$V_{CEO}$	250	V
发射极—基极直流电压 Emitter-Base Voltage	$V_{EBO}$	5.0	V
最大集电极电流 Collector Current	$I_C$	8	A
最大基极电流 Base Current	$I_B$	2	A
耗散功率 Total Power Dissipation( $T_c=25^\circ\text{C}$ )	$P_D$	50	W
最高结温 Junction Temperature	$T_j$	150	$^\circ\text{C}$
贮存温度 Storage Temperature	$T_{stg}$	-55~150	$^\circ\text{C}$



# MJE15032(NPN) MJE15033(PNP)

## 电特性 ELECTRICAL CHARACTERISTIC

项 目 Parameter	测试条件 Tests conditions	最小值 Value(min)	典型值 Value(typ)	最大值 Value(max)	单位 Unit
$V_{(BR)CEO}$	$I_C=10mA, I_B=0$	250	-	-	V
$I_{CBO}$	$V_{CB}=250V, I_E=0$	-	-	10	$\mu A$
$I_{EBO}$	$V_{EB}=5V, I_C=0$	-	-	10	$\mu A$
hFE	$V_{CE}=5V, I_C=0.5A$	70	-	-	-
hFE	$V_{CE}=5V, I_C=1.0A$	50	-	-	-
hFE	$V_{CE}=5V, I_C=2.0A$	10	-	-	-
$V_{CE(sat)}$	$I_C=1A, I_B=0.1A$	-	-	0.5	V
$V_{BE(ON)}$	$V_{CE}=5V, I_C=1.0A$	-	-	1.0	V
$f_T$	$V_{CE}=10V, I_C=0.5A, f=1.0MHz$	30	-	-	MHz

## 热特性 THERMAL CHARACTERISTIC

项 目 Parameter	符 号 Symbo	最小值 min	最大值 max	单 位 Unit
结到管壳的热阻 Thermal Resistance Junction Case	$R_{th(j-c)}$	-	2.5	$^{\circ}C/W$

## 特征曲线 ELECTRICAL CHARACTERISTICS (curves)

### MJE15032(NPN)

### MJE15033(PNP)

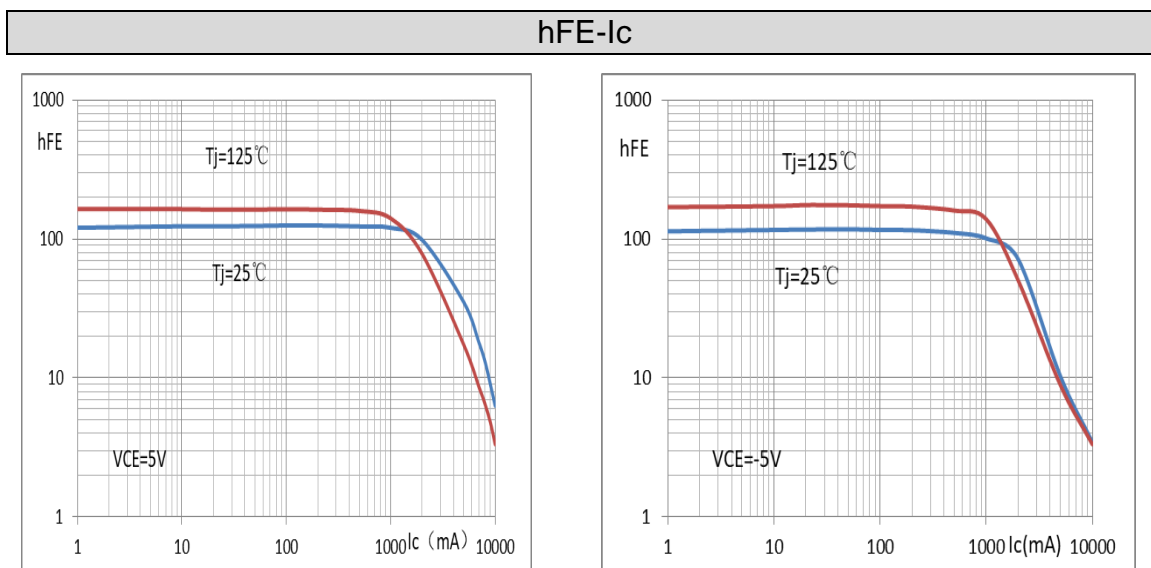



# MJE15032(NPN) MJE15033(PNP)

### VBE(on)-Ic

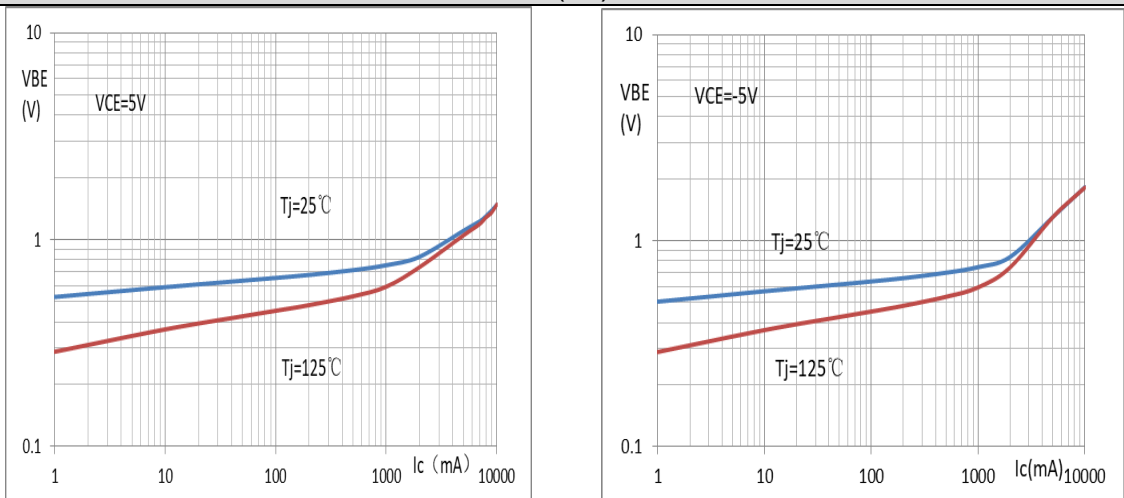

### VCE(sat)-Ic

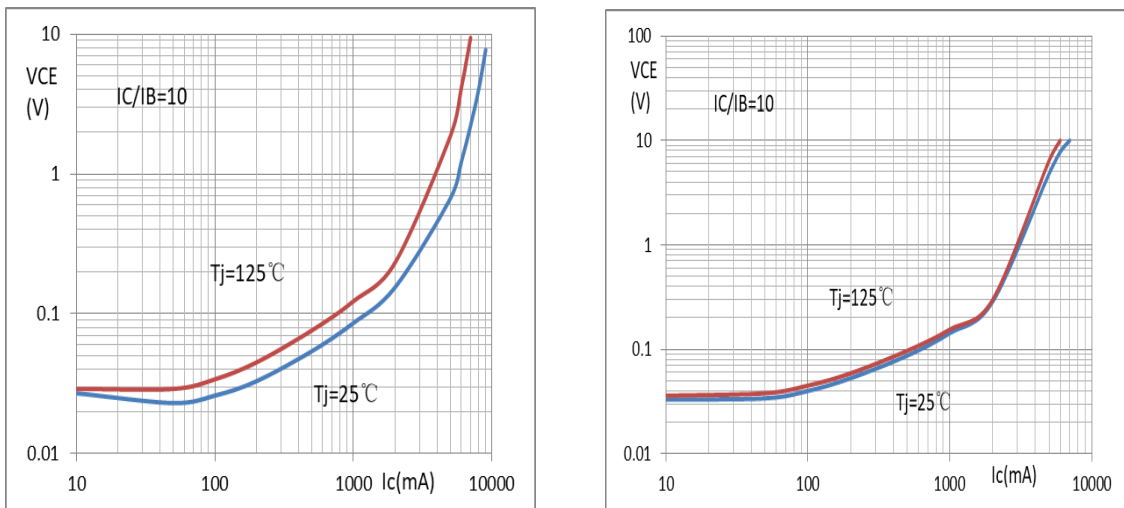

### VCE(sat)-Ic

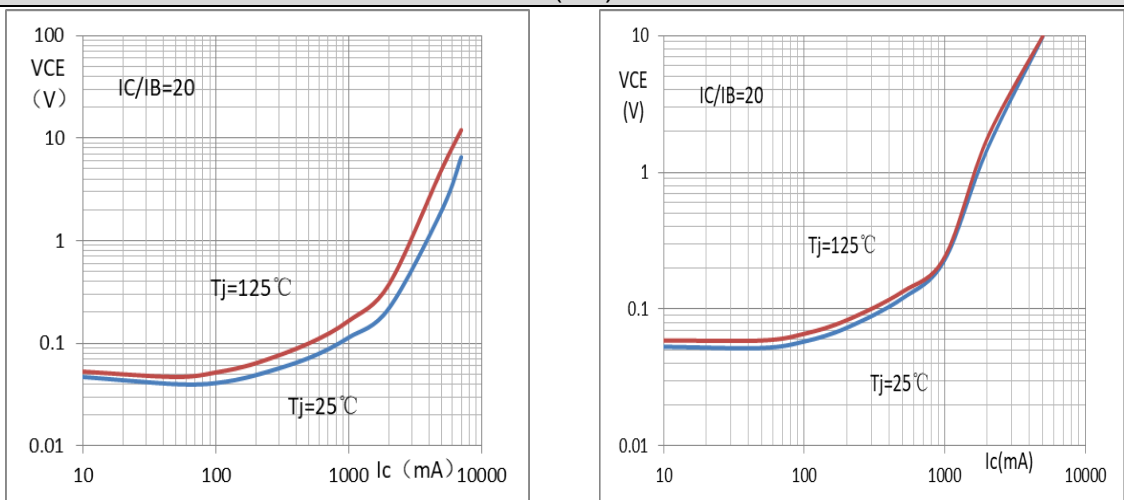



# MJE15032(NPN) MJE15033(PNP)

### VBE(sat)-Ic

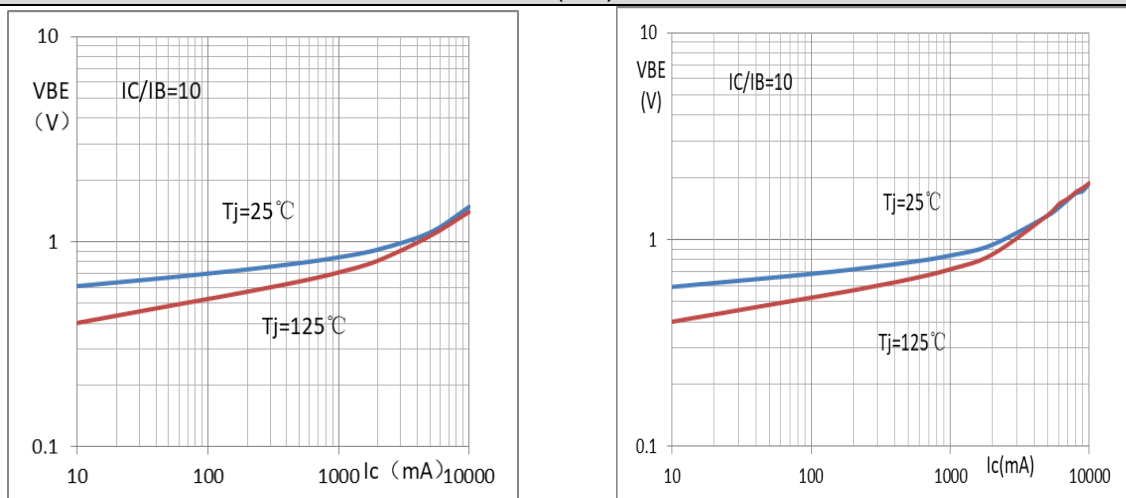

### SOA

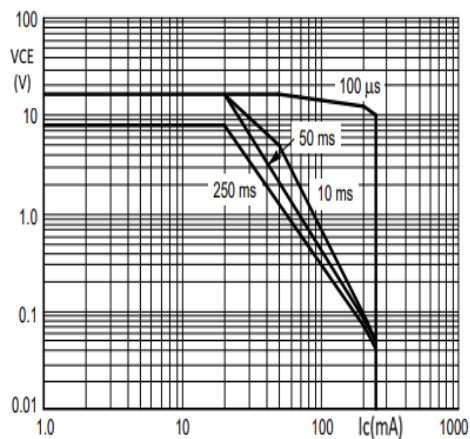



# MJE15032(NPN) MJE15033(PNP)

## 外形尺寸 PACKAGE MECHANICAL DATA

### TO-220C

单位 Unit : mm

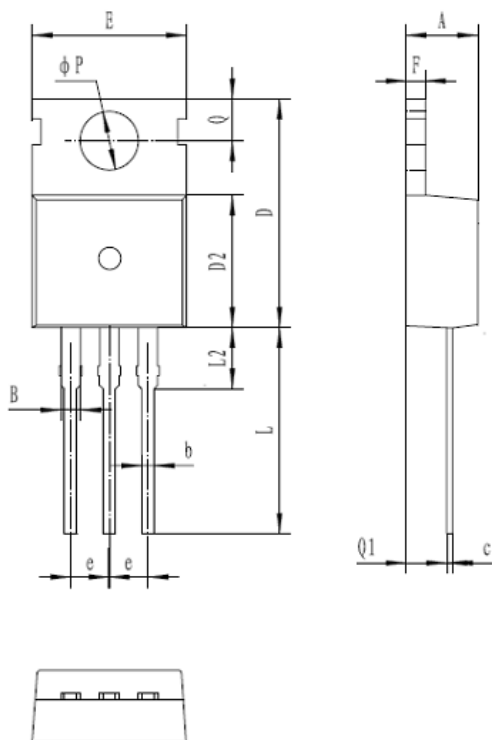

符号	尺寸 (mm)
A	4.30-4.70
B	1.10-1.40
b	0.70-0.95
c	0.40-0.65
D	15.20-16.20
D2	9.00-9.40
E	9.70-10.10
e	2.39-2.69
F	1.25-1.40
L	12.60-13.60
L2	2.80-3.20
P	3.50-3.80
Q	2.60-3.00
Q1	2.20-2.60



## MJE15032(NPN) MJE15033(PNP)

### 注意事项

1. 吉林华微电子股份有限公司的产品销售分为直销和销售代理，无论哪种方式，订货时请与公司核实。
2. 购买时请认清公司商标，如有疑问请与公司本部联系。
3. 在电路设计时请不要超过器件的绝对最大额定值，否则会影响整机的可靠性。
4. 本说明书如有版本变更不另外告知

### NOTE

1. Jilin Sino-microelectronics co., Ltd sales its product either through direct sales or sales agent , thus, for customers, when ordering , please check with our company.
2. We strongly recommend customers check carefully on the trademark when buying our product, if there is any question, please don't be hesitate to contact us.
3. Please do not exceed the absolute maximum ratings of the device when circuit designing.
4. Jilin Sino-microelectronics co., Ltd reserves the right to make changes in this specification sheet and is subject to change without prior notice.

### 联系方式

#### 吉林华微电子股份有限公司

公司地址：吉林省吉林市深圳街 99 号

邮编：132013

总机：86-432-64678411

传真：86-432-64665812

网址：[www.hwdz.com.cn](http://www.hwdz.com.cn)

#### 市场营销部

地址：吉林省吉林市深圳街 99 号

邮编：132013

电话：86-432-64675588

64675688

64678411

传真：86-432-4671533

### CONTACT

#### JILIN SINO-MICROELECTRONICS CO., LTD.

ADD: No.99 Shenzhen Street, Jilin City, Jilin Province, China.

Post Code: 132013

Tel: 86-432-64678411

Fax: 86-432-64665812

Web Site: [www.hwdz.com.cn](http://www.hwdz.com.cn)

#### MARKET DEPARTMENT

ADD: No.99 Shenzhen Street, Jilin City, Jilin Province, China.

Post Code: 132013

Tel: 86-432-64675588

64675688

64678411

Fax: 86-432-64671533