



# JT030N065AED

## 主要参数 MAIN CHARACTERISTICS

$I_c$	30A
$V_{CES}$	650V
$V_{CE(sat)}$ -TYP	1.5V

### 用途

- 逆变器
- UPS 电源

### APPLICATIONS

- General purpose inverters
- UPS

### 产品特性

- 低栅极电荷
- Trench FS 技术
- RoHS 产品
- 低  $V_{CEsat}$

### FEATURES

- Low gate charge
- Trench FS Technology
- RoHS product
- Low  $V_{CEsat}$

## 封装 Package

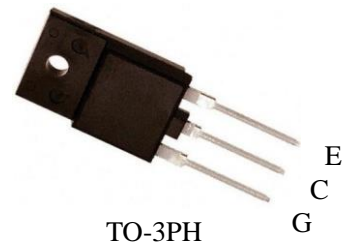
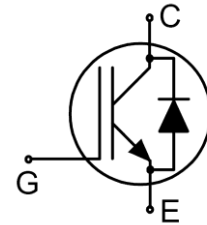

TO-3PH

## 订货信息 ORDER MESSAGE

订货型号 Order codes		印记 Marking	封装 Package
有卤-条管 Halogen-Tube	无卤-条管 Halogen-Free-Tube		
JT030N065AED-GA-B	JT030N065AED-GA-BR	JT030N065AED	TO-3PH

绝对最大额定值 ABSOLUTE RATINGS (T<sub>C</sub>=25℃)

项 目 Parameter	符 号 Symbol	数 值 Value	单 位 Unit
最高集电极-发射极直流电压 Collector-Emmitter Voltage	V <sub>CE</sub>	650	V
*连续集电极电流 Collector Current-continuous T <sub>C</sub> =25℃ T <sub>C</sub> =100℃	I <sub>C</sub>	60 30	A
最大脉冲集电极极电流 Collector Current – pulse (pw<1ms, duty cycle ≤0.01)	I <sub>CM</sub>	120	A
二极管正向测试电流 Diode RMS forward current T <sub>C</sub> =25℃ T <sub>C</sub> =100℃	I <sub>F</sub>	60 30	A
二极管正向脉冲电流 Diode pulse current (pw<1ms, duty cycle ≤0.01)	I <sub>FSM</sub>	120	A
栅极发射极电压 Gate-Emmitter Voltage 瞬态栅极发射极电压 Transient Gate-emitter voltage (pw≤10us, duty cycle <0.01)	V <sub>GE</sub>	±20 ±30	V
安全工作区 Turn-off safe area	-	120	A
耗散功率 Power Dissipation T <sub>C</sub> =25℃ T <sub>C</sub> =100℃	P <sub>D</sub>	71 35	W
存储温度 Storage Temperature Range	T <sub>STG</sub>	-55~+150	℃
结温 Junction Temperature Range	T <sub>J</sub>	-40~+175	℃
引线最高焊接温度 Maximum Lead Temperature for Soldering Purposes	T <sub>L</sub>	300	℃
绝缘耐压 Isolation Voltage	V <sub>ISO</sub>	1500	V

\*连续集电极电流由最高结温限制

\*Collector current limited by maximum junction temperature



## 电特性 ELECTRICAL CHARACTERISTICS

项 目 Parameter	符 号 Symbol	测试条件 Tests conditions	最小 Min	典型 Typ	最大 Max	单位 Units
<b>关态特性 Off –Characteristics</b>						
集电极-发射极击穿电压 Collector-Emmitter Voltage	$BV_{CES}$	$I_C=250\mu A, V_{GE}=0V$	650	-	-	V
零栅压下集电极漏电流 Zero Gate Voltage Collector Current	$I_{CES}$	$V_{CE}=650V, V_{GE}=0V, T_C=25^\circ C$	-	-	100	$\mu A$
		$V_{CE}=650V, V_{GE}=0V, T_C=175^\circ C$	-	-	2	mA
正向栅极体漏电流 Gate-body leakage current,forward	$I_{GESF}$	$V_{CE}=0V, V_{GE}=20V$	-	-	200	nA
反向栅极体漏电流 Gate-body leakage current,reverse	$I_{GESR}$	$V_{CE}=0V, V_{GE}=-20V$	-	-	-200	nA
<b>通态特性 On-Characteristics</b>						
阈值电压 Gate Threshold Voltage	$V_{GE(th)}$	$V_{CE}=V_{GE}, I_C=250\mu A$	4.5	-	6.5	V
饱和压降 Collector-Emmitter saturation Voltage	$V_{CESAT}$	$V_{GE}=15V, I_C=30A, T_C=25^\circ C$	-	1.5	2.1	V
		$V_{GE}=15V, I_C=30A, T_C=125^\circ C$	-	1.8	-	V
		$V_{GE}=15V, I_C=30A, T_C=175^\circ C$	-	2.0	-	V
<b>动态特性 Dynamic Characteristics</b>						
输入电容 Input capacitance	$C_{ies}$	$V_{CE}=25V, V_{GE}=0V, f=1.0MHz$	-	1830	-	pF
输出电容 Output capacitance	$C_{oes}$		-	160	-	pF
反向传输电容 Reverse transfer capacitance	$C_{res}$		-	50.3	-	pF
栅极电荷总量 Total Gate Charge	$Q_g$	$V_{CC}=520V, I_C=30A, R_g=7.9\Omega, V_{GE}=15V, T_C=25^\circ C$	-	64.5	-	nC
栅极-反射极 Gate to emitter charge	$Q_{ge}$		-	18.1	-	
栅极-集电极 Gate to collector charge	$Q_{gc}$		-	23.7	-	
栅极电阻-Gate resistance	$R_g$	$f=1MHz, \text{open collector}$	-	1.1	-	$\Omega$
短路电流-short current	$I_{sc}$	$V_{GE}=15V, V_{CE}=300V, t\leq 10\mu s$	-	150	-	A





## 电特性 ELECTRICAL CHARACTERISTICS

## 开关特性 Switching Characteristics

项 目 Parameter	符 号 Symbol	测试条件 Tests conditions	最小 Min	典型 Typ	最大 Max	单位 Units
开启延迟时间 Turn-on delay time	td(on)	V <sub>CC</sub> =400V, I <sub>C</sub> =30A, R <sub>g</sub> =7.9Ω V <sub>GE</sub> =15 V T <sub>C</sub> =25°C	-	27.0	-	ns
上升时间 Turn-on rise time	tr		-	67.0	-	ns
关断延迟时间 Turn-off delay time	td(off)		-	67.0	-	ns
下降时间 Turn-off Fall time	tf		-	44.0	-	ns
开通损耗 Turn-on energy	Eon		-	0.83	-	mJ
关断损耗 Turn-off energy	Eoff		-	0.36	-	mJ
总开关损耗 Total switching energy	Etot		-	1.19	-	mJ
开启延迟时间 Turn-on delay time	td(on)	V <sub>CC</sub> =400V, I <sub>C</sub> =30A, R <sub>g</sub> =7.9Ω V <sub>GE</sub> =15 V T <sub>C</sub> =175°C	-	27.0	-	ns
上升时间 Turn-on rise time	tr		-	68.0	-	ns
关断延迟时间 Turn-off delay time	td(off)		-	90.0	-	ns
下降时间 Turn-off Fall time	tf		-	59.0	-	ns
开通损耗 Turn-on energy	Eon			1.09		mJ
关断损耗 Turn-off energy	Eoff			0.58		mJ
总开关损耗 Total switching energy	Etot			1.67		mJ
关断电压变化率 Turn-off dv/dt	dv/dt	V <sub>CC</sub> =400V, I <sub>C</sub> =30A, R <sub>g</sub> =10Ω V <sub>GE</sub> =15 V, T <sub>C</sub> =25°C		6140		V/us

## 反并联二极管特性及最大额定值 Anti-Parallel Diode Characteristics and Maximum Ratings

正向压降 Diode Forward Voltage	V <sub>F</sub>	V <sub>GE</sub> =0V, I <sub>F</sub> =15A	-	1.5	2.2	V
反向恢复时间 Reverse recovery time	t <sub>rr</sub>	V <sub>GE</sub> =0V, V <sub>R</sub> =400V, I <sub>F</sub> =30A dI <sub>F</sub> /dt=100A/μs T <sub>C</sub> =25°C	-	40	-	ns
反向恢复电荷 Reverse recovery charge	Q <sub>rr</sub>		-	26.4	-	nC
反向恢复电流 Diode Reverse recovery Current	I <sub>rrm</sub>		-	1.16	-	A
反向恢复时间 Diode Reverse recovery time	t <sub>rr</sub>	V <sub>GE</sub> =0V, V <sub>R</sub> =400V I <sub>F</sub> =30A dI <sub>F</sub> /dt=100A/μs T <sub>C</sub> =175°C	-	194	-	ns
反向恢复电荷 Diode Reverse recovery charge	Q <sub>rr</sub>		-	409	-	nC
反向恢复电流 Diode Reverse recovery Current	I <sub>rrm</sub>		-	3.8	-	A

项 目 Parameter	符 号 Symbol	Typ	Max	单 位 Unit
IGBT 结到管壳的热阻 IGBT thermal Resistance, Junction -Case	R <sub>th(j-c)</sub>	1.86	2.1	°C/W
Diode 结到管壳的热阻 Diode thermal Resistance, Junction -Case	R <sub>th(j-c)</sub>	2.6	2.95	°C/W



特征曲线 ELECTRICAL CHARACTERISTICS (curves)

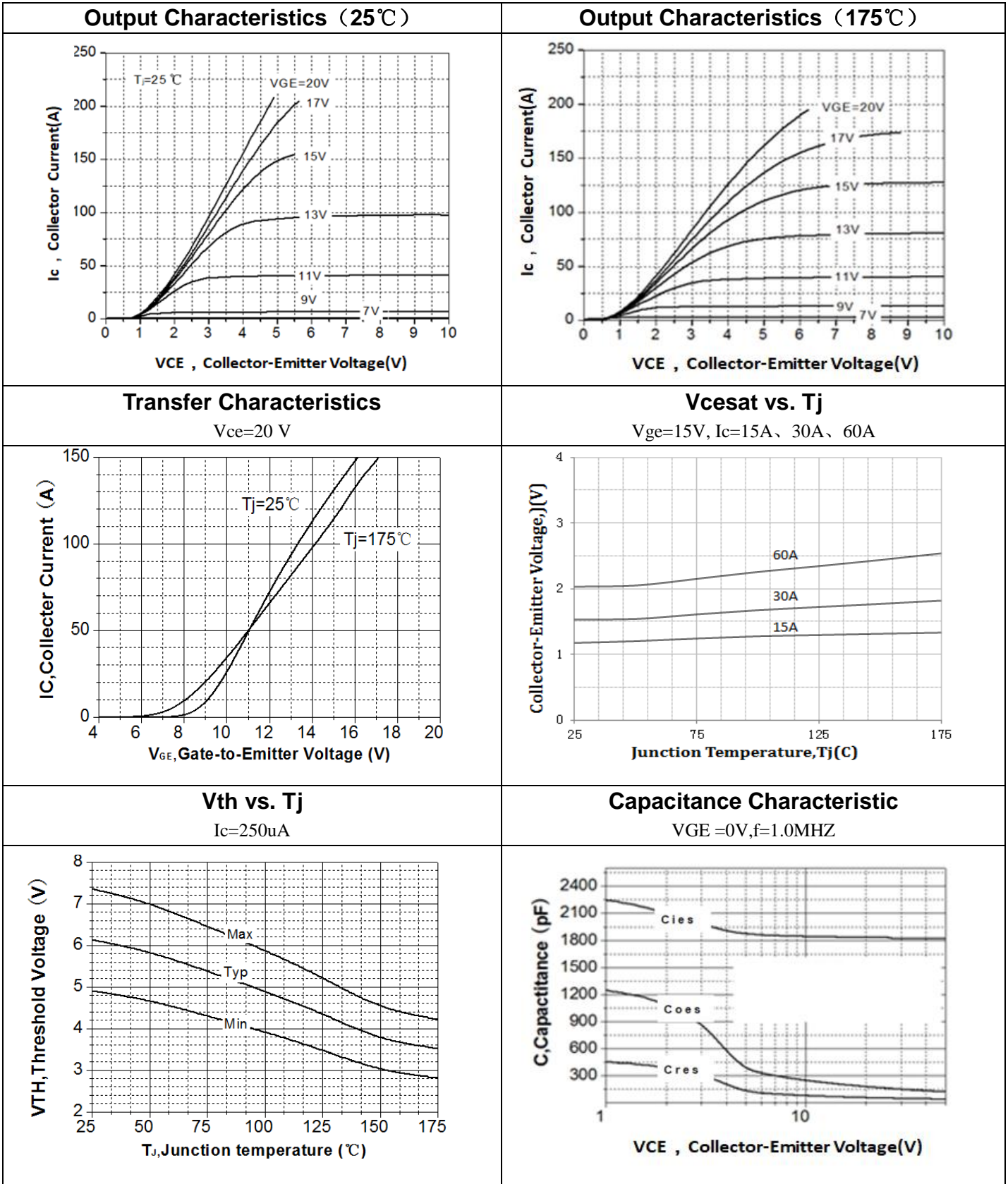

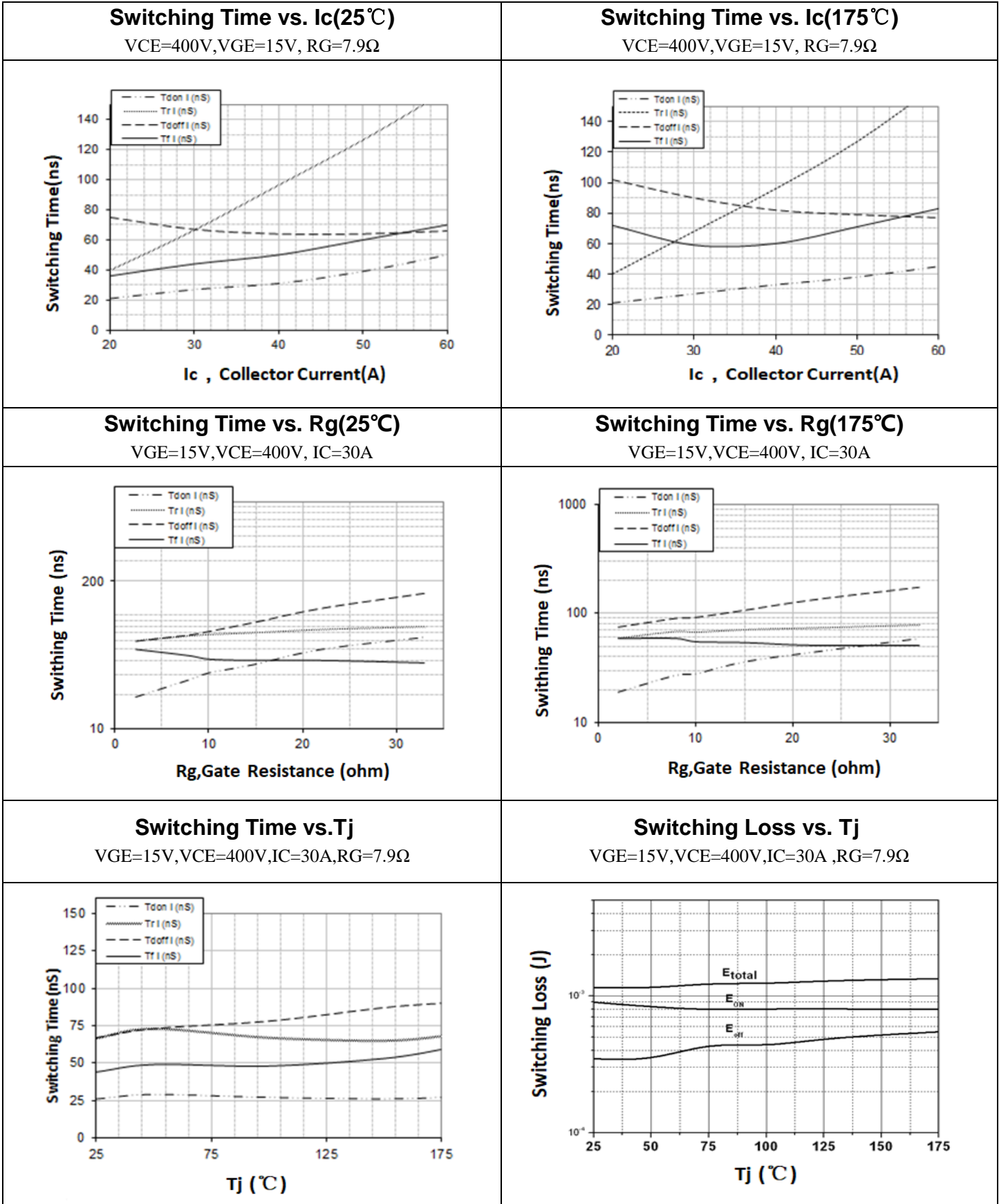



**Switching Loss vs. Ic(25°C)**

VGE=15V, VCE=400V, RG=7.9Ω

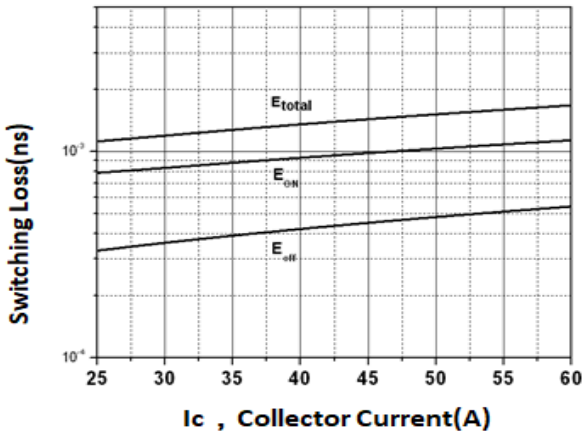

**Switching Loss vs. Ic(175°C)**

VGE=15V, VCE=400V, RG=7.9Ω

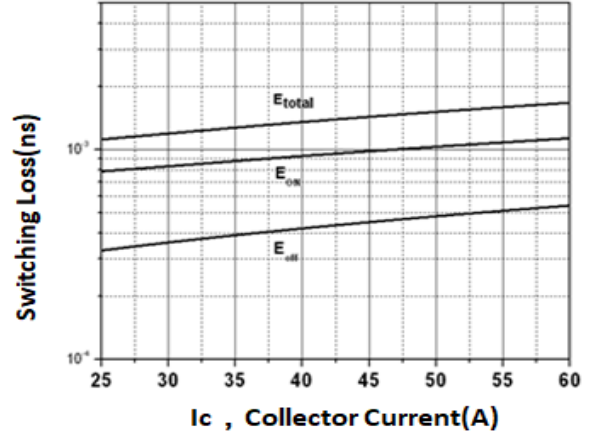

**Switching Loss vs. Rg(25°C)**

VGE=15V, VCE=400V, IC=30A

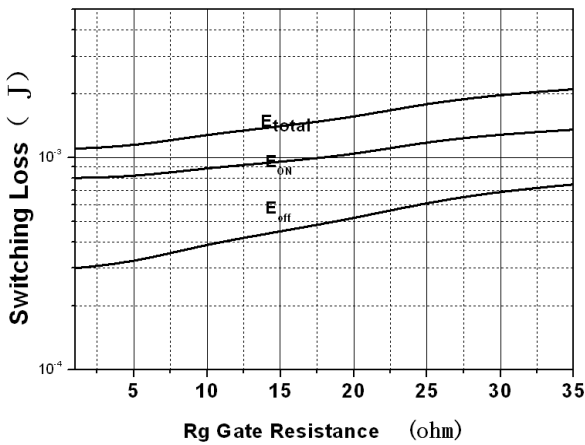

**Switching Loss vs. Rg(175°C)**

VGE=15V, VCE=400V, IC=30A

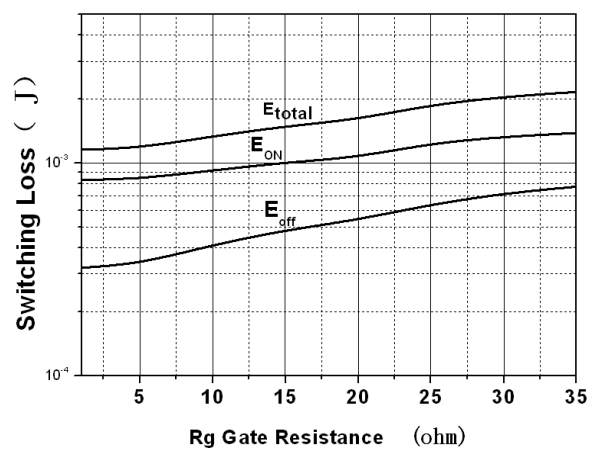

**Switching Loss vs. VCE(175°C)**

VGE=15V, IC=30A, RG=7.9Ω

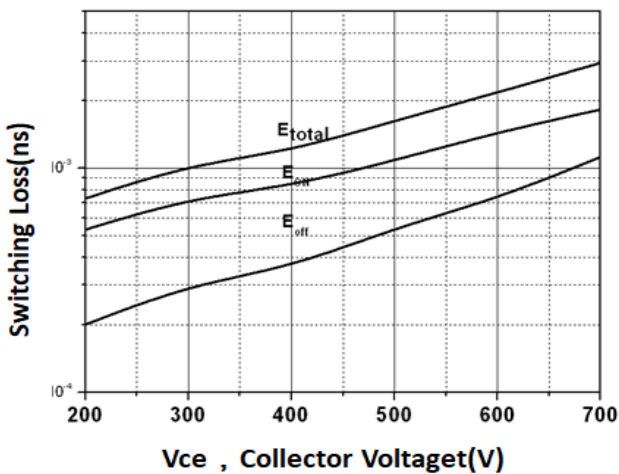

**Forward Bias Safe Operating Area**

Tc=25 °C, VGE=15V, Tvj ≤ 150 °C

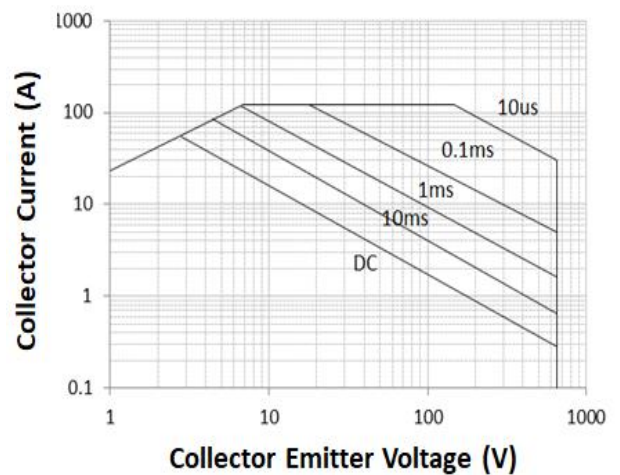



Ic vs. Tc

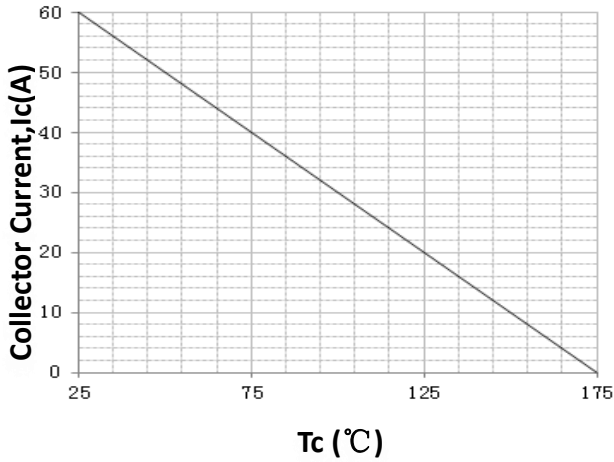

Vf vs. Tj

Ic=7.5A、15A、30A

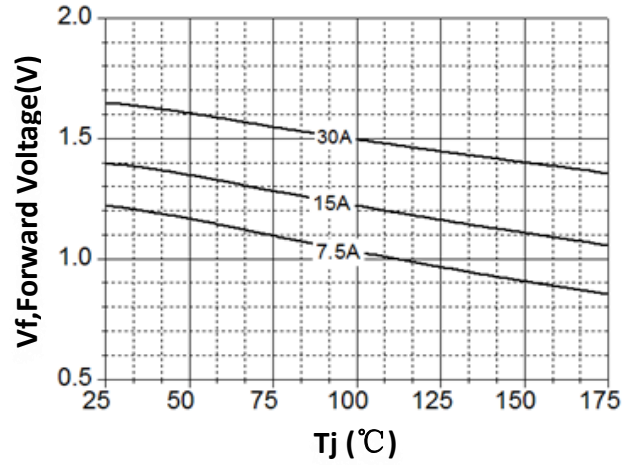

Diode Characteristic

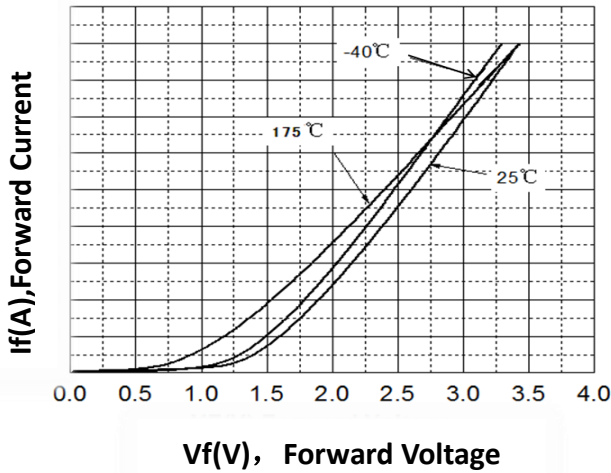

Transient Thermal Impedance IGBT

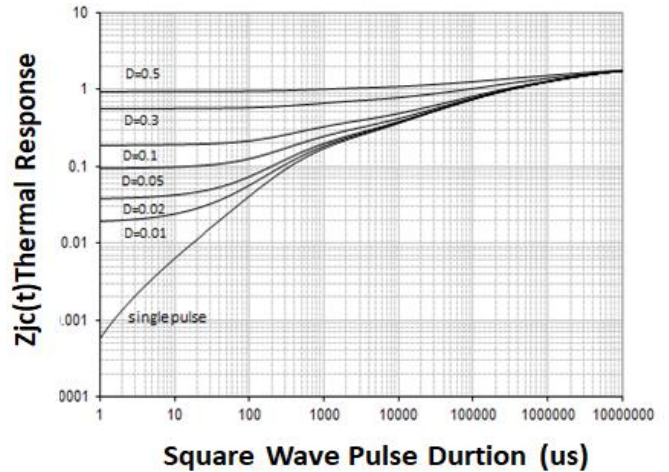

Reverse Bias Safe Operating Area

Tc=25 °C, VGE=±15V, Rg=10 Ω, Tvj ≤ 150°C

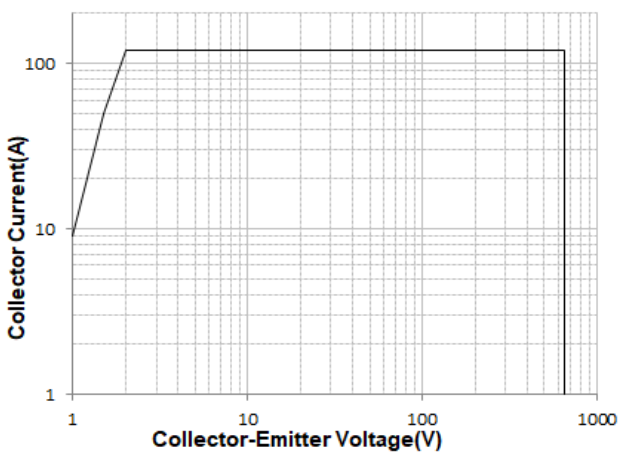

Transient Thermal Impedance

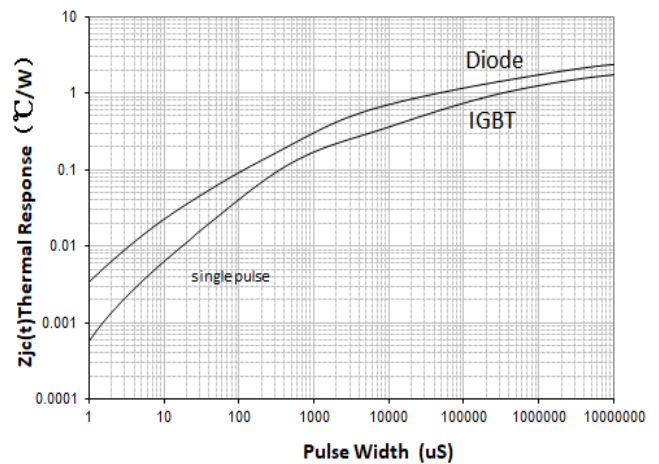





## 外形尺寸 PACKAGE MECHANICAL DATA

TO-3PH

单位 Unit: mm

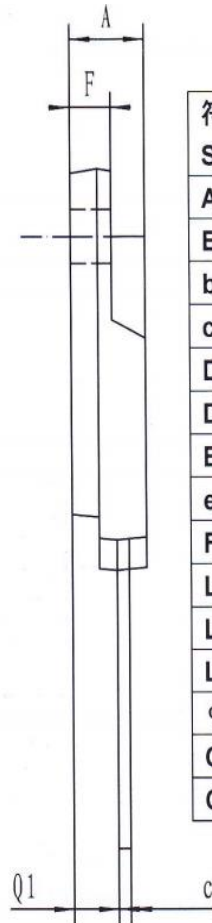
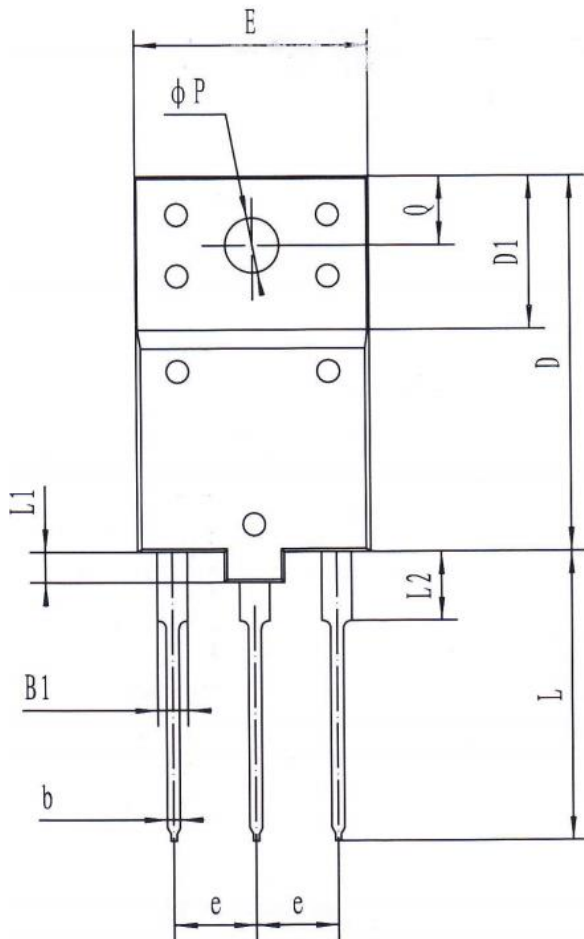

符号 Symbol	Min	Max
A	5.2	5.8
B1	1.8	2.2
b	0.75	1.05
c	0.8	1.1
D	24.0	25.0
D1	9.8	10.2
E	15.0	16.0
e	5.45 (typ)	
F	2.7	3.3
L	18.5	19.5
L1	1.8	2.2
L2	4.3	4.7
φP	3.4	3.8
Q	4.3	4.7
Q1	3.1	3.5



1. 吉林华微电子股份有限公司的产品销售分为直销和销售代理，无论哪种方式，订货时请与公司核实。
2. 购买时请认清公司商标，如有疑问请与公司本部联系。
3. 在电路设计时请不要超过器件的绝对最大额定值，否则会影响整机的可靠性。
4. 本说明书如有版本变更不另外告知。

## NOTE

1. Jilin Sino-microelectronics co., Ltd sales its product either through direct sales or sales agent , thus, for customers, when ordering , please check with our company.
2. We strongly recommend customers check carefully on the trademark when buying our product, if there is any question, please don't be hesitate to contact us.
3. Please do not exceed the absolute maximum ratings of the device when circuit designing.
4. Jilin Sino-microelectronics co., Ltd reserves the right to make changes in this. specification sheet and is subject to change without prior notice.

## 联系方式

### 吉林华微电子股份有限公司

公司地址：吉林省吉林市深圳街 99 号

邮编：132013

总机：86-432-64678411

传真：86-432-64665812

网址：[www.hwdz.com.cn](http://www.hwdz.com.cn)

## CONTACT

### JILIN SINO-MICROELECTRONICS CO., LTD.

ADD: No.99 Shenzhen Street, Jilin City, Jilin Province, China.

Post Code: 132013

Tel: 86-432-64678411

Fax: 86-432-64665812

Web Site: [www.hwdz.com.cn](http://www.hwdz.com.cn)